

META META SLIM Mitigeur monocommande de lavabo avec garniture d'écoulement - Orange

















META

33 501 662



- saillie 125 mm
- bec déverseur fixe
- jet circulaire enrichi en air
- hauteur de robinetterie 134 mm
- hauteur jusqu'au mousseur 52 mm
- diamètre de percement 35 mm
- 2x flexible de pression M 8 x 1 vissé, étanchéité contrôlée
- débit maxi. 5,7 l/min
- sans plomb
- Ce produit contribue au respect des exigences des systèmes d'évaluation des bâtiments écologiques, par exemple LEED®, BREEAM®, DGNB

Convient uniquement à un lavabo avec trop-plein.

| | | |
|---|-----------------------------|---------------|
|  | Orange | 33 501 662-30 |
|  | Chrome | 33 501 662-00 |
|  | Platine brossé | 33 501 662-06 |
|  | Platine | 33 501 662-08 |
|  | Dark Chrome | 33 501 662-19 |
|  | Or clair | 33 501 662-26 |
|  | Or clair brossé | 33 501 662-27 |
|  | Laiton brossé (Or 23cts) | 33 501 662-28 |
|  | Rouge | 33 501 662-29 |
|  | Vert foncé | 33 501 662-31 |
|  | Noir mat | 33 501 662-33 |
|  | Bronze brossé | 33 501 662-42 |
|  | Champagne brossé (Or 22cts) | 33 501 662-46 |
|  | Champagne (Or 22cts) | 33 501 662-47 |
|  | Chrome brossé | 33 501 662-93 |
|  | Dark Platinum brossé | 33 501 662-99 |

META META SLIM Mitigeur monocommande de lavabo avec garniture d'écoulement - Orange

META

33 501 662
mm [inches]



Diagramme de débit



33 501 662

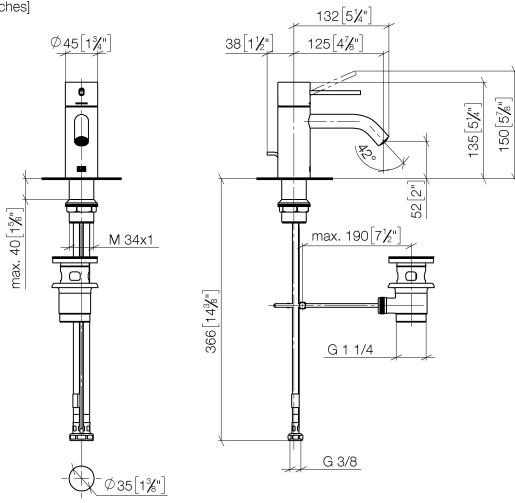